

Linearization of Characteristics of Relative Humidity Sensor and Compensation of Temperature Impact

Toshko Nenov and Stefan Ivanov*

Technical University of Gabrovo, Hadji Dimitar 4, Gabrovo 5300, Bulgaria

(Received February 20, 2006; accepted March 30, 2007)

Key words: intelligent sensor, ceramic sensing elements, linearization, artificial neural network

The present paper contains a review of software methods for linearization. A description is given of the properties of ceramic sensing elements for relative humidity sensors. A realization of a sensor for relative humidity with linearization of the characteristic and compensation of the temperature effect has been described as well. The use of artificial neural networks (ANNs) is compared with other methods for linearization.

1. Introduction

Sensors play an important role in modern measurement and control systems. The developers of new types of sensor aim to improve their precision and functionality. There are many methods of hardware and software compensation for nonlinearities, narrowing the error range and improving accuracy. They include different techniques for the linearization of sensor characteristics and reduction of impacts of disturbing phenomena.

Generally, the characteristics of sensors are nonlinear and they have to be linearized. The linearization is mainly a software approach to improving sensor accuracy. There are different methods for this⁽¹⁾ and they could be classified as follows:

- look-up tables
- polygonal interpolation
- polynomial approximation
- cubic spline interpolation
- linearization with artificial neural networks (ANNs)

Each of these methods has unique features, which are reflected on its software

*Corresponding author: e-mail: st_ivanov@abv.bg

implementation, required processing resources, and the accuracy that can be achieved by it.

The look-up table is a method easy to implement. Pairs of points from the nonlinear sensor characteristics and real values of a measured phenomenon are placed in the nonvolatile memory. A microcontroller uses these data pairs for the evaluation of measured data. A disadvantage of this method is that many pairs of points have to be used to achieve a suitable accuracy. This is reflected on the memory size necessary for storage of a look-up table.

Polygonal interpolation,⁽¹⁾ as compared with look-up tables, needs fewer points to linearize sensor characteristics. Spaces between each pair of adjacent points are interpolated with straight lines. When the characteristic has a high degree of nonlinearity, we need more points to achieve higher accuracy and to reduce errors.

Polynomial approximation linearizes sensor characteristics using polynomials. The most widely used polynomials are third-order polynomials. The more nonlinear a characteristic and a more local minimums and maximums it has, the higher-order polynomials have to be used.

Using spline interpolation, we can build a curve that passes through all of the reference points. The spaces between every two adjacent reference points are represented by parabolas.

A very advanced method for linearization is the utilization of ANNs.⁽²⁻⁹⁾ A neural network consists of neurons, grouped in layers. An artificial neuron resembles the functionality of a biological neuron. The most commonly used ANNs are feed-forward networks.⁽¹⁰⁾ They can be trained using the back-propagation training algorithm. ANNs can be used together with other methods for information processing, such as digital signal processing and fuzzy logic.⁽¹⁰⁾ Interaction between neural networks and fuzzy logic takes place when fuzzy logic⁽¹¹⁾ is used for preliminary data processing before feeding the data to a neural network. The reversed process is also possible.

The main aim of the current paper is to present the linearization of RH sensor characteristic and compensation of the effect of temperature on it using an ANN as well as to offer a prototype of that sensor.

2. Characteristics of Ceramic Sensing Elements for Relative Humidity

One of the trends in the development of relative humidity sensors is based on thin-film and thick-film ceramic sensing elements.⁽¹²⁾ They have advantages such as small dimensions, not requiring very sophisticated technology for manufacturing, comparatively low price and resistance to harsh environments. This group of sensors includes those in which the relative humidity sensing elements are porous semiconductive or dielectric ceramic, or ceramic layers, based on one or several oxides. These sensing elements show high resistance when the humidity is low, nonlinear characteristics, polarization when DC voltage is applied and temperature dependence. These features require the development of appropriate conditioning electronics. Ceramic sensing elements can be classified into two groups, depending on the type of electrical conductivity, namely, electron conductivity and ion conductivity.

When the sensors are of the ion conductivity type, the decrease in sensing element resistance, owing to the increase in humidity depends on the sorption on the sensing element surface and condensation of water in the microcapillary of the ceramics. Sensors of the electron conductivity type use the effect of chemisorption. The molecules of water act as donor centers and provide electrons to the ceramics.

The operation principle of ceramic sensors of relative humidity is based on the sorption of moisture from the ambient environment. Changes in the physicochemical and electrophysical parameters of sensors are the main factors for the measurement of humidity in the environment. The equivalent electrical circuit of ceramic sensing element is complex. It can be simplified and presented as resistance R_H and capacitance C_H connected in parallel. The impedance of the circuit, Z_H , for frequency f , can be formulated as:

$$Z_H = \frac{R_H}{1 + j\omega R_H C_H}, \quad (1)$$

where $\omega = 2\pi f$. Depending on the kind of prevailing conductivity, the sensing element can act as either a resistive or a capacitive element.

Current research focuses on ceramic sensing elements based on TiO_2 with components synthesized using a conventional ceramic technology. The constituents included in ceramics are PbO and Bi_2O_3 . The different types of ceramic sensing element are synthesized at 1050°C and 850°C (see Table 1). The dependence of resistance and capacitance on relative humidity ($R_H=f(H)$ and $C_H=f(H)$) are presented in Fig. 1.

Figure 2 shows the basic parts of sensor electronics for signal conditioning. With the help of this electronics, sensor impedance is transformed to DC voltage. An RC generator is used for generation of sinusoidal signals. The generator works in the range from 100 Hz to 10 kHz. Sinusoidal signals are used to avoid the negative effects of polarization.

Voltage obtained from the amplitude detector is amplified by a noninverting amplifier. Figure 3 shows the humidity-to-voltage ratio of three experimental sensing elements.

3. Results and Discussion

3.1. Utilization of ANN for approximation of sensor characteristics

An artificial neural network consists of neurons. They can be treated as a set of computational objects for parallel data processing. There are different models of

Table 1
Composition and synthesis temperature of experimental samples.

Sample	Composition	Temperature of synthesis
TO10(1050)	90% mol TiO_2 + 10% mol PbO	1050°C
TO10(850)	90% mol TiO_2 + 10% mol PbO	850°C
TB5(1050)	95% mol TiO_2 + 5% mol Bi_2O_3	1050°C

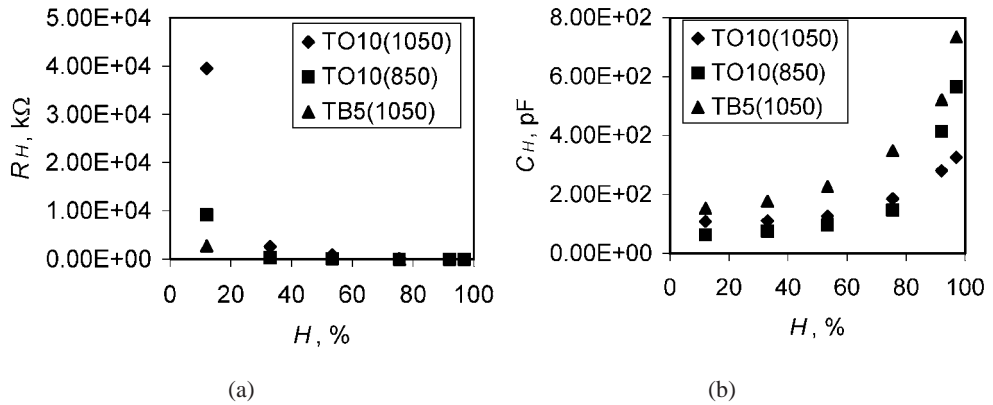

Fig.1. Relationship of R_H and C_H with relative humidity.

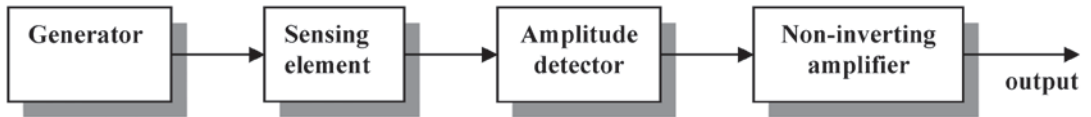

Fig. 2. Flow chart of sensor electronics.

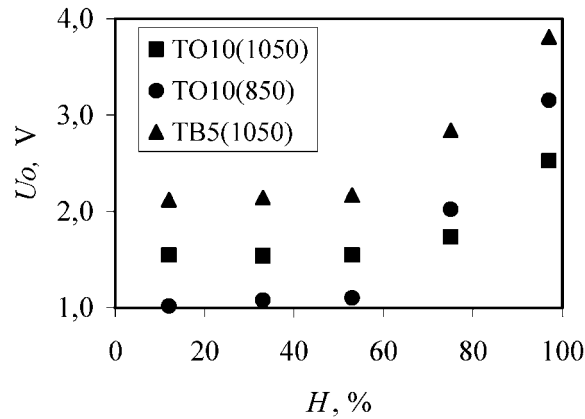

Fig. 3. Output characteristic of relative humidity sensor .

artificial neurons and several types of neural network. The ANN can be implemented as a hardware circuit or a software program. The structure of an ANN is shown in Fig. 4.

To work properly, the neural network must be trained with a set of training data. The sequence of the training process is as follows.

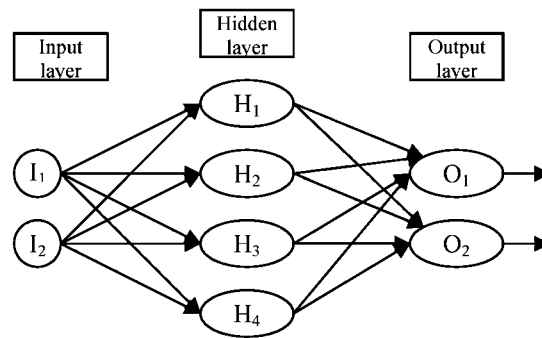

Fig. 4. ANN structure.

- 1) Training data acquisition. In our case, we measure the output voltage at several points. These points represent relative humidity achieved using concentrated salt solution.
- 2) The neural network is trained using the Neural Network Toolbox of Matlab.
- 3) The trained network is verified to determine whether it was trained properly.

3.2. Linearization of sensor characteristics using neural network

Several types of ANN with different numbers of neurons and activation functions were examined. The input data in the training process consist of pairs of voltage values, measured at the output of the conditioning electronic circuit and relative humidity values, which appear over the surfaces of the hermetically closed solutions of different types of salt. Table 2 includes data for the T010(850) sensing element sample.

On the basis of the acquired data set and using the Matlab function for shape-preserving interpolation, the sensor characteristic was plotted as shown in Fig. 5.

Figure 5 shows that the characteristic is nonlinear and the sensor has higher sensitivity in the range of the ambient humidity from 50 to 100%.

After testing several types of ANN, a neural network with one hidden layer was chosen. The network has feed-forward architecture. It was trained using the Levenberg-Marquardt algorithm. The error after this training was 0.0097. The chosen network has three neurons in its hidden layer and one neuron in the output layer. The generated output data from the network is shown in Fig. 6.

The neurons in the hidden layer have a sigmoid function of activation. The outputs of neurons can have values between 0 and 1. The only neuron in the output layer has a linear function of activation and the value of its output can vary from minus infinity to plus infinity. Each of the neurons of the hidden layer has one input, where voltage is fed, generated by the relative humidity sensor.

The characteristics of ceramic sensing elements depend on ambient temperature. Every temperature change leads to a change in the resistance of ceramic elements. Table 3 shows the characteristics of a sensing element based on the TO10(850) material in the range from 20 to 50°C. An improvement of sensor accuracy can be achieved only after

Table 2

Training data of neural network for T010(850) sensing element linearization.

Uo, [V]	1.018	1.095	1.165	1.26	1.55	2.022	2.51	3.156
RH, [%]	12	33	44	53	64	75	85	97

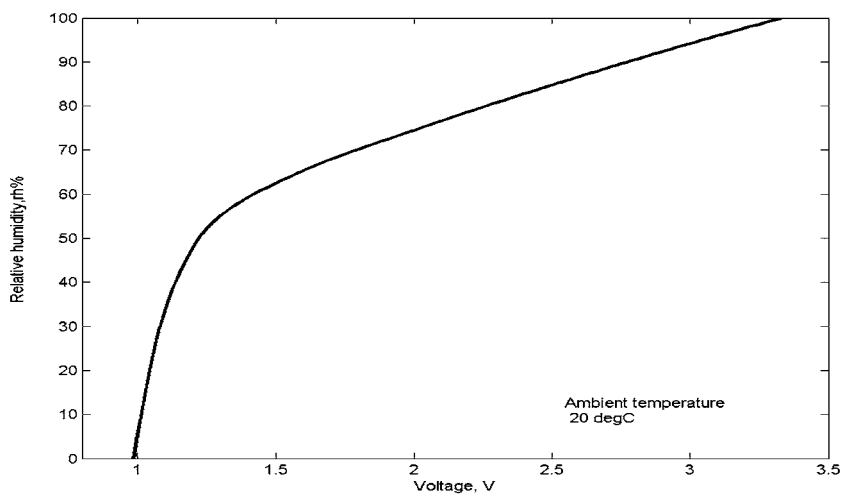

Fig. 5. Relative humidity sensor characteristic.

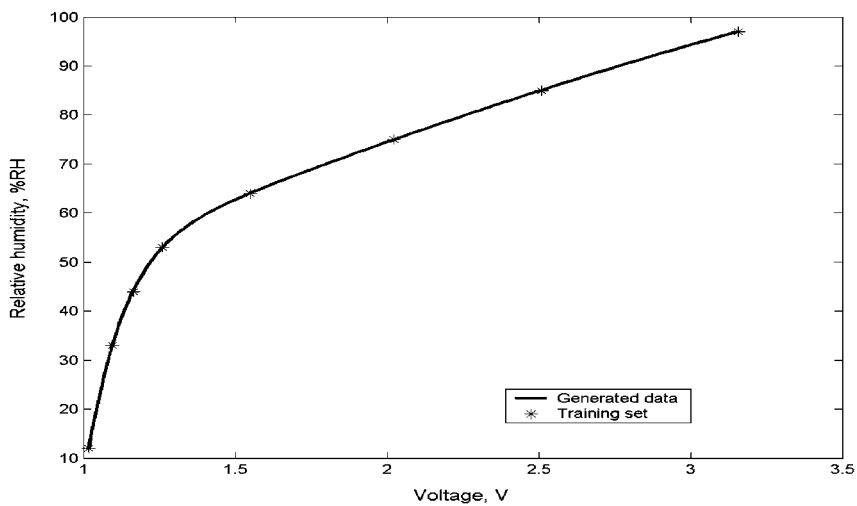

Fig. 6. Output data generated from trained network.

Table 3
Temperature effect on sensor characteristics (voltage values are shown in grey).

RH%	T, °C					
	20°C	25°C	30°C	40°C	50°C	
12%	1.018	1.036	1.044	1.058	1.078	
33%	1.095	1.114	1.122	1.136	1.156	
44%	1.165	1.183	1.191	1.205	1.225	
53%	1.26	1.278	1.286	1.300	1.320	
64%	1.55	1.568	1.577	1.591	1.612	
75%	2.022	2.04	2.049	2.064	2.085	
85%	2.51	2.53	3.539	3.554	3.575	
97%	3.156	3.176	3.186	3.202	3.224	

the compensation for the temperature effect on sensing element characteristics.

To compensate for the temperature effect on the sensor characteristics, we used a neural network with 12 neurons in the hidden layer. Every neuron in the hidden layer has two inputs – one for voltage coming from the sensor, and the other for temperature coming from a low-cost temperature sensor. The output layer consists of one neuron. The output response of a trained ANN is shown in Fig. 7.

3.3 Practical realization of a relative humidity sensor

In order to apply in practice the results obtained from the linearization of the characteristic and compensation of the temperature effect different approaches can be taken. The neural network can be realized using specialized neuron chips, programmable logic devices and microcontrollers or DSP processors.

The specialized neuron chips are electronic components dedicated to the building of ANN processing systems. Several firms offer commercial modifications of such devices. They have features such as a high computation speed of the neural network and a large number of layers and neurons and unfortunately, high price. Most of these chips are designed for implementation of complex neural networks.

Using programmable logic devices (CPLD, FPGA) it is possible to build parallel structures for data processing, such as ANNs. Each neuron takes a separate part from the programmable logic and working in parallel can achieve a high computational speed. Some drawbacks of FPGA are the relatively high price of the chips as well as certain difficulties in realizing mathematical operations with real numbers.

The third approach for building ANNs is to use microcontrollers or DSP processors. Most microcontrollers and DSP processors have an affordable price and easy to use

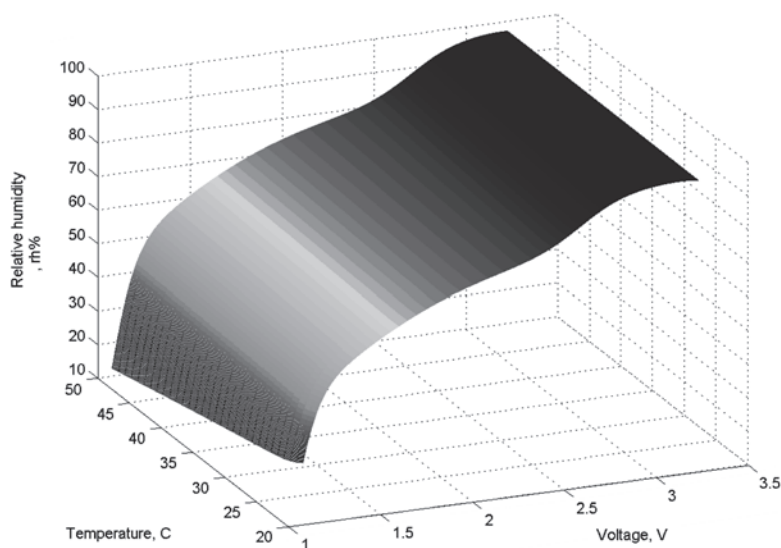

Fig. 7. Temperature compensation using ANN.

development tools with C compilers and debugging capabilities. These features make them appropriate for the realization of small neural networks.

It is used an 8 bit microcontroller – Pic18F242, with the following features: RISC architecture, hardware multiplier, 10 bit analog-to-digital converter, 4 timers, USART, SPI and I²C interfaces. The computational power of this microcontroller is sufficient for our case, because the process of relative humidity change is slow and there are no demands for utilization of a high-end microcontroller. The structure of the sensor prototype is presented in Fig. 8.

When it is used an ANN to evaluate the sensor response without compensation of the temperature effect, the network has three neurons in the hidden layer and the time necessary for data processing is 8.4 ms. The oscillator of the microcontroller is 20 MHz, and the program is written in C.

When it is compensated the temperature effect it is used an ANN with 12 neurons in the hidden layer. Before building the neural network in C, Matlab was used for evaluating the neural network weights and biases. Weight and biases values are stored in the EEPROM memory of the microcontroller. The algorithm operates as follows:

- 1) reading ADC value corresponding to RH sensor,
- 2) reading ADC value corresponding to the temperature and evaluation of the temperature,
- 3) both ADC values for relative humidity and temperature come into the inputs of the neural network,
- 4) the neural network processes the entered data using weights and biases stored in EEPROM memory,
- 5) evaluation of the value of relative humidity in percent.

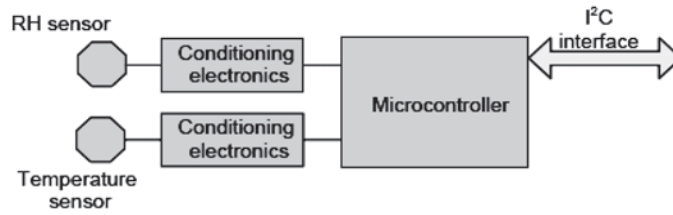

(a)

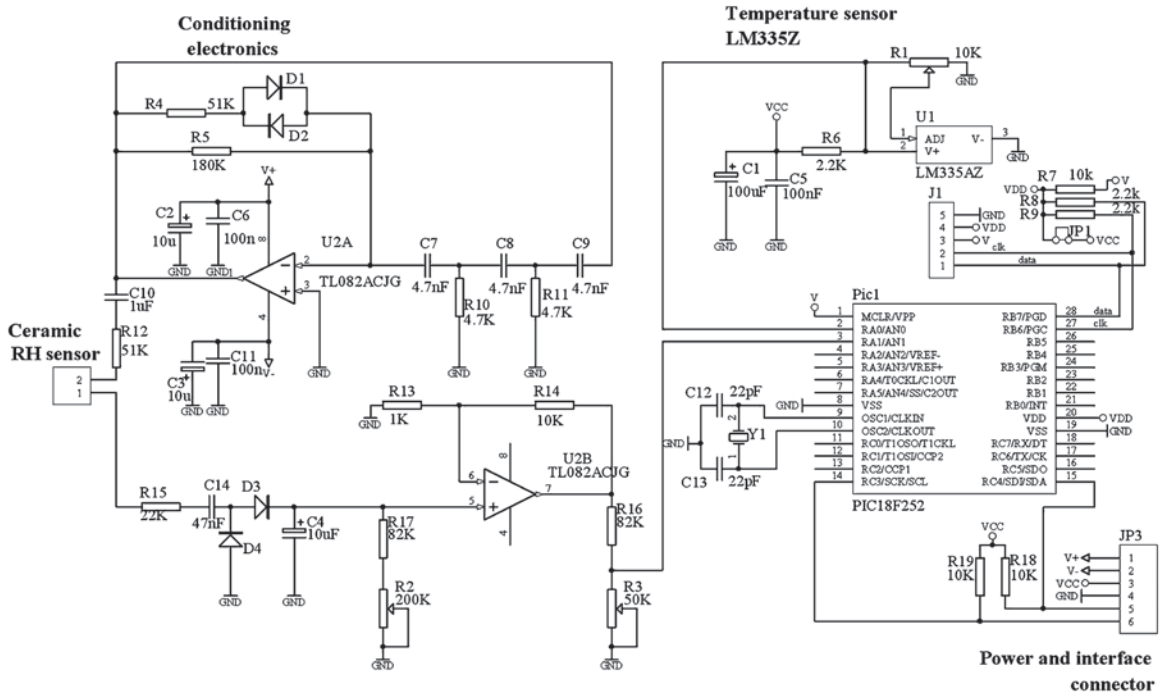

(b)

Fig. 8. Block diagram of RH sensor (a) and schematics (b).

The processing time of this ANN is 30.2 ms, which is acceptable in our case. The software of the microcontroller also contains functions for temperature calibration, communication functions for I²C protocol and a simple command parser.

3.4. Comparison between ANN and polynomial approximations

Three control points were used for the evaluation of error contained in the ANN response for these points. The computation of error was based on the following formula:

$$\gamma = \frac{\Delta R_H}{R_{H_{\max}} - R_{H_{\min}}} \cdot 100\%, \quad (2)$$

where ΔR_H is the difference between relative humidity generated by the ANN and real relative humidity defined from the type of salt solution.

$$\Delta R_H = R_{H_ANN} - R_{H_REAL} \quad (3)$$

The control points used for the validation of the neural network results are 22, 80 and 92% relative humidity.

The results of the validation are shown in Table 4. The results generated by a well-trained neural network were compared with those obtained using polynomials. For the purposes of this comparison, second third- and fourth-order polynomials were used. Figure 9 shows the shapes of responses of the ANN and polynomials for the entire range of voltage changes.

It can be observed from Fig. 9 that the neural network fits the input data better than polynomials. The results of this comparison are shown in Table 5.

4. Conclusion

The present paper describes the linearization of the characteristic of a ceramic sensor for relative humidity using artificial neural networks. The realization of an intelligent

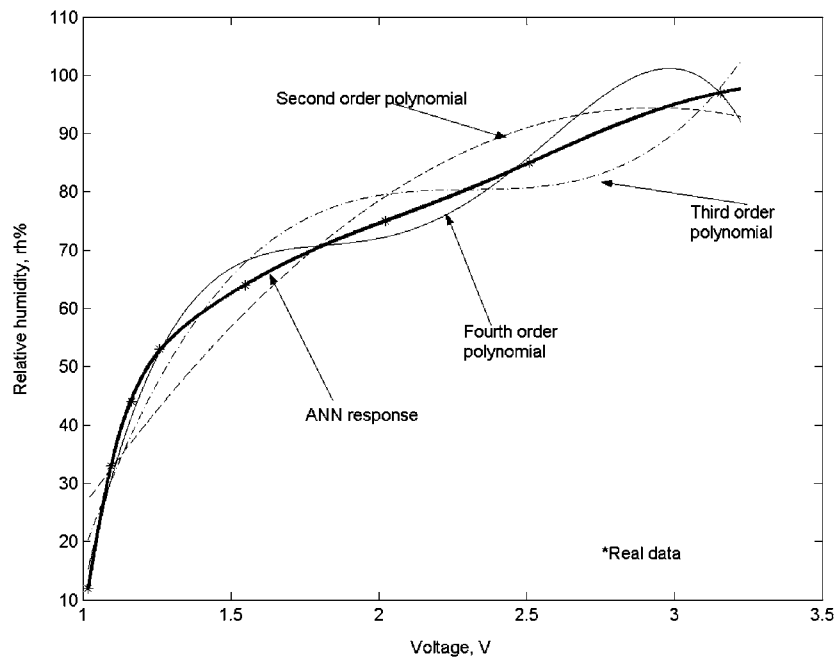

Fig. 9. Comparison between ANN and polynomial approximations.

Table 4
ANN response error.

Real relative humidity, RH%	22	80	92
Voltage, V	1.05	2.25	2.88
Calculated relative humidity, RH%	21.494	79.383	92.931
ΔR_H , RH%	0.506	0.617	-0.931
γ , %	0.595	0.726	-1.095

Table 5
Comparison of results.

U_o , [V]	1.018	1.095	1.165	1.26	1.55	2.022	2.51	3.156
RH_{real} , %RH	12	33	44	53	64	75	85	97
$RH_{second_order_polynomial}$, %RH	27.1807	32.4735	37.0969	43.0849	59.3218	79.1705	91.1236	93.5482
$RH_{third_order_polynomial}$, %RH	20.2527	30.3083	38.4114	47.9316	67.8824	79.5481	80.7390	97.9266
$RH_{fourth_order_polynomial}$, %RH	15.2844	30.5012	41.4260	52.5260	68.1216	72.2383	86.0273	96.8750
RH_{ANN} , %RH	12.0253	32.8679	44.2280	52.8405	64.0637	74.9574	85.0224	96.9954

sensor with temperature effect compensation on the basis of an 8-bit microcontroller has been shown as well. A comparison of the ANN method with other methods of approximation has been made, and the error for every method at several control points has been shown. For this type of sensor characteristic the ANN gives better results than polynomials. The compensation of temperature effect using ANN improves the accuracy of the sensor in wide temperature ranges.

References

1. J. Brignell and N. White: Intelligent Sensor Systems (Institute of Physics Publishing, Bristol, UK, 1994)
2. R. L. Harvey: Neural Network Principles (Prentice-Hall, Inc., Englewood Cliffs, New Jersey, 1994)
3. Y. Tairight and M. Hubin: Hardware Reconfigurable Neural Network for Electronic Nose (Sensor, 1999) p. 611–616.
4. P. Corcoran and P. Lowery: Sensor Review **15** (1995) 15.
5. F. Davide: Sensors and Actuators B **18** (1994) 244.

6. G. Niebling and A. Schlachter: *Sensors and Actuators B* **26** (1995) 289.
7. M. Pardo and G. Sberveglieri: *IEEE Transactions on Instrumentation and Measurement* (2002) p. 1334–1339.
8. F. Aminian and M. Aminian: *IEEE Transactions on Instrumentation and Measurement* (2002) p. 544–550
9. L. Biel and P. Wide: *IEEE Instrumentation & Measurement Magazine* (2000) p. 27–30.
10. S. Osovskii: *Neural networks for processing of information (Finance and statistics, Moscow, 2000)*.
11. Y.-S. Hong, H. Jin and C.-K. Park: (*IEEE Transaction on Fuzzy Systems*, 1999) p. 759–767
12. T. Nenov and S. Yordanov: *Ceramic sensors: Technology and Applications* (Technomic Publ. Inc., Lancaster-Basel, 1996).