

High-Order Statistics for Fluctuation-Enhanced Gas Sensing

Janusz M. Smulko^{1,2} and Laszlo B. Kish^{1*}

¹Department of Electrical Engineering, Texas A&M University,
College Station, TX 77843-3128, USA

²Gdansk University of Technology, WETiI, ul. G. Narutowicza 11/12 80-952 Gdansk, Poland

(Received January 23, 2004; accepted May 26, 2004)

Key words: gas detection, gas recognition, stochastic processes, sensor signal processing, pattern generation

The stochastic component of a chemical sensor signal contains valuable information that can be visualized not only by spectral analysis but also by methods of high-order statistics (HOS). The analysis of HOS enables the extraction of nonconventional features and may lead to significant improvements in selectivity and sensitivity. We pay particular attention to the bispectrum that characterizes the non-Gaussian component and detects nonstationarity in analyzed noise. The results suggest that the bispectrum can be applied to gas recognition. The analysis of bispectra and the reproducibility statistics of skewness and kurtosis indicate that the measured time records were stationary.

1. Introduction

Generally, the output signal U_{sens} of a chemical sensor can be written as

$$U_{sens}(t) = U_{reg} + x_{stoc}(t), \quad (1)$$

where U_{reg} is the regular component of the sensor signal and $x_{stoc}(t)$ is the stochastic component, which in the ideal case is determined by dynamical microscopic interactions between the sensor and the molecules of the agent sensed. It has been shown that the stochastic signal component $x_{stoc}(t)$ is a valuable source of information that can be used to improve both selectivity and sensitivity.^(1–5) We have called sensing methods based on

*Corresponding author, e-mail address: laszlo.kish@ee.tamu.edu

stochastic signal analysis, fluctuation-enhanced sensing (FES). The standard FES method has been limited to measuring the power spectral density $S_x(f)$ and analyzing its pattern.⁽¹⁻⁴⁾ It is often assumed that the stochastic process is Gaussian and therefore it does not contain any additional (non-Gaussian) information. However, the observed signal often contains non-Gaussian components, particularly in sensors having small volumes or inhomogeneous current densities. Thus the analysis of these non-Gaussian components has the potential of significantly improving the sensitivity and selectivity of electronic noses.⁽⁵⁾

In this exploratory study, we have investigated the nonlinear stochastic properties of commercial Taguchi-type sensors by applying high-order statistical (HOS) tools. Taguchi sensors are surface-active, grainy, semiconductive oxide (usually SnO_{2-x})-based gas-sensing films working at elevated temperatures.⁽⁶⁾ The grain size can be as small as 10 nanometers. The stochastic sensor signal is represented by the temporal microscopic fluctuations in the sensor resistance, and these fluctuations are influenced by the ambient gas.^(1,2) The sensor's DC resistance is dominated by charge carrier transport through the potential barriers at intergrain boundaries (Fig. 1(a)).⁽⁶⁾ The barrier is formed when the metal oxide crystal is heated in air, and oxygen is adsorbed which acts as a donor due to its negative charge. The barrier height is reduced⁽⁶⁾ when the concentration of oxygen ions decreases in the presence of a reducing gas (Fig. 1(b)). As a result, DC resistance decreases. The gas-induced stochastic resistance fluctuations are caused by the fluctuations in the local oxygen concentration at the grain boundary junctions.⁽¹⁾ These concentration fluctuations have two different origins.⁽³⁾

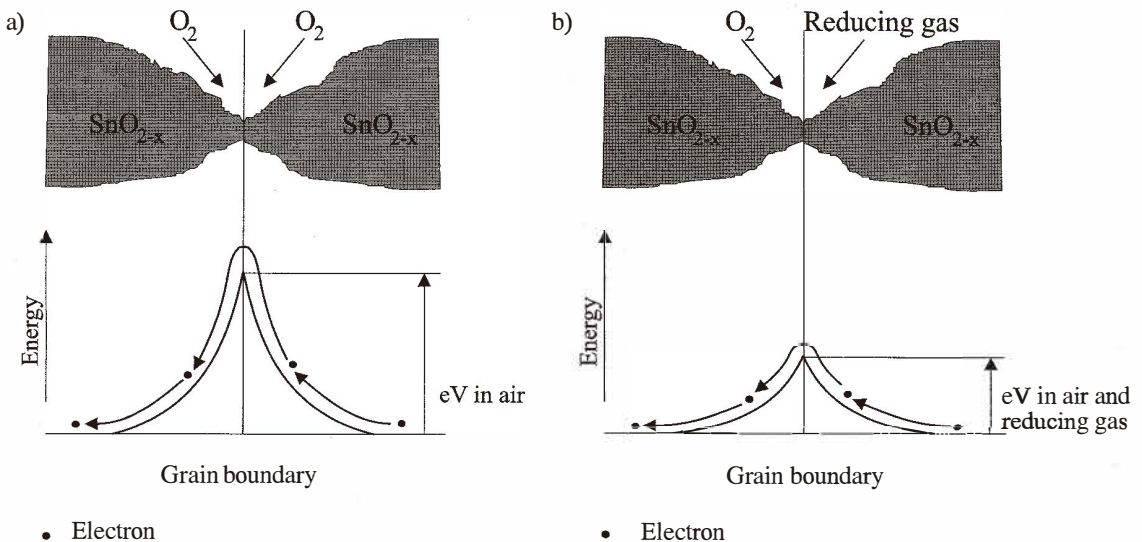

Fig. 1. Potential barrier between grains in (a) air and (b) reducing gases.

- The stochastic nature of the absorption-desorption process, which has also been observed in surface-acoustic-wave (SAW) devices, and is controlled by the adhesion energy of the gas molecules at the surface
- The stochastic nature of surface diffusion process (random walk) which is characterized by the activation energy of surface diffusion

These two microphysical stochastic processes are always present; however, usually one is dominant.⁽³⁾ The actual situation is determined by geometry, activation and adhesion energies, and the time scale (frequency range) of the measurement.

In this paper, we exploit the information captured in the HOS of the recorded stochastic signal of commercial Taguchi sensors.

2. Method, Setup and Sensors

2.1 HOS methods

A stationary stochastic signal $x(t)$ is characterized separately by its power spectral density (PSD) and amplitude density. Usually, it is assumed that the observed noise is a Gaussian stochastic process, implying a Gaussian amplitude density, in which case the PSD completely characterizes its statistical properties. However, non-Gaussian stochastic processes are often present, and they play an important role in various semiconductor devices.⁽⁷⁻⁹⁾ For example, in the presence of random telegraph noise, the observed deviation from a Gaussian distribution is used for reliability predictions for semiconductor devices.⁽⁹⁾

Let us suppose that the $x(t)$ sensor signal is sampled and recorded as a time series $x(n)$. Simple measures of deviations⁽¹⁰⁾ from the Gaussian distribution are skewness, γ_3 , and kurtosis, γ_4 . These parameters are computed for a discrete-time random process $x(n)$ having the standard deviation σ_x as

$$\gamma_3 = \frac{1}{\sigma_x^3} E\left[\left(x(n) - E[x(n)]\right)^3\right] \quad (2)$$

$$\gamma_4 = \frac{1}{\sigma_x^4} E\left[\left(x(n) - E[x(n)]\right)^4\right] - 3, \quad (3)$$

where $E[\]$ denotes averaging. The skewness describes the degree of symmetry and the kurtosis measures the relative peakedness of the distribution. Both measures are equal to zero for a Gaussian process.

An important tool to investigate the non-Gaussian component of the stochastic sensor signal is the bispectrum.⁽¹⁰⁻¹¹⁾ The bispectrum function is the second-order Fourier transform of the third-order cumulant,⁽¹¹⁾

$$S_{3x}(f_1, f_2) = \sum_{k=-\infty}^{\infty} \sum_{l=-\infty}^{\infty} C_{3x}(k, l) e^{-j2\pi f_1 k} e^{-j2\pi f_2 l}, \quad (4)$$

where $C_{3x}(k, l) = E[x(n)x(n+k)x(n+l)]$ is the third-order cumulant of the zero-mean process $x(n)$. The bispectrum is a two-dimensional complex function. Usually, its absolute value is analyzed, which is a three-dimensional landscape. The bispectrum function is equal to zero for processes with zero skewness, i.e., for Gaussian processes. The bispectrum of two statistically independent random processes equals the sum of the bispectra of the individual random processes. It is an important property of bispectra that Gaussian components in the recorded stochastic process are eliminated and only the non-Gaussian components are visible.⁽¹¹⁾

The above definition of the bispectrum function yields axial symmetries for stationary random signals (Fig. 2), where each section between the symmetry axes characterizes the entire function. The lack of any of these symmetries indicates that the analyzed process is not stationary.

2.2 Measurement setup

The experimental setup (Fig. 3) consists of a gas mixer, a stainless steel sensor chamber, a Stanford Instruments preamplifier, an AD Instruments PowerLab Data Acquisition system and a personal computer. The passive current generator driving the sensor film (two-contact arrangement) and the preamplifier were battery-powered.

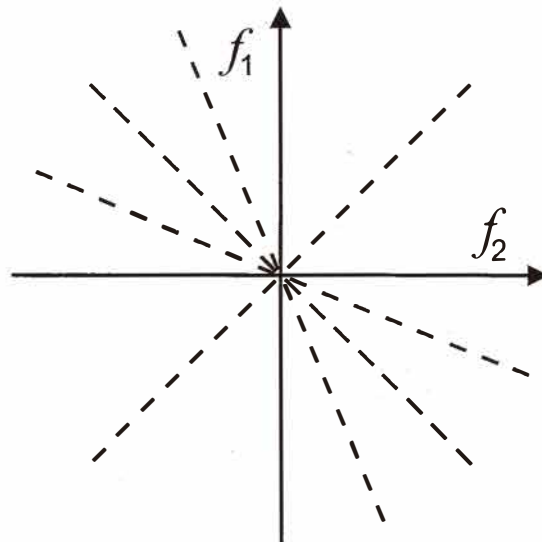

Fig. 2. Symmetry axes of bispectrum function.

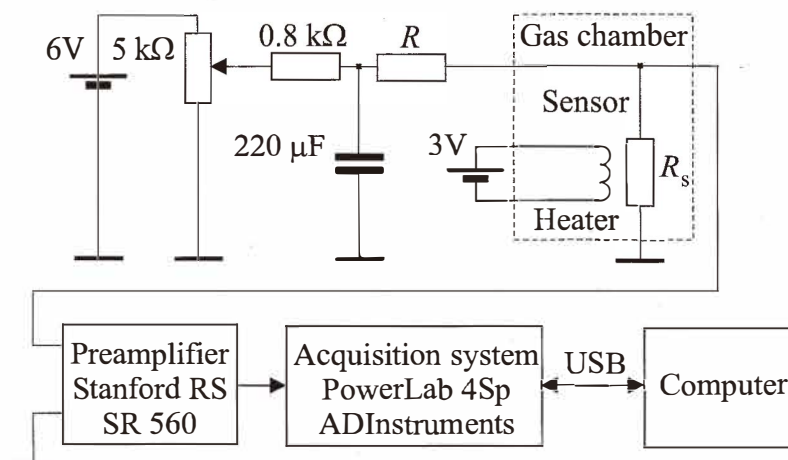

Fig. 3. Measurement setup.

The flow of the gas mixture through the sensor chamber was controlled and maintained constant. For the exploratory study of bispectra-based responses, we have measured the following four gas mixtures.

- Synthetic air (flow 0.165 l/min)
- Ethanol (70 ppm) in synthetic air (flow 0.215 l/min)
- Hydrogen (380 ppm) in synthetic air (flow 0.265 l/min)
- Alcohol fumes (saturated ethanol vapor in closed sensor chamber)

The data were collected at sampling frequencies $f_s=20$ kHz and $f_s=100$ Hz. The noise bandwidth was appropriately limited by the preamplifier filter to avoid aliasing effects. The load resistance R was chosen to have approximately the same value as the sensor resistance R_s .

2.3 Sensors

Two commercially available Taguchi-type gas sensors were investigated: RS 286-636 (designed for the detection of carbon monoxide) and RS 286-642 (designed for the detection of nitrogen oxide).

3. Results and Discussion

We found that the properties of measured stochastic resistance fluctuations were characteristic of the gas mixture used in the experiment. The normalized power spectra $fS_x(f)/U_{DC}^2$ of ethanol (70 ppm), hydrogen (380 ppm) and synthetic air are shown in Fig. 4, recorded with sampling frequency $f_s=20$ kHz and 400,000 data points. The normalized power spectra show distinctive characteristics (Fig. 4). At the same time, the amplitude density was nearly Gaussian (Fig. 5). Stronger deviations from the normal distribution

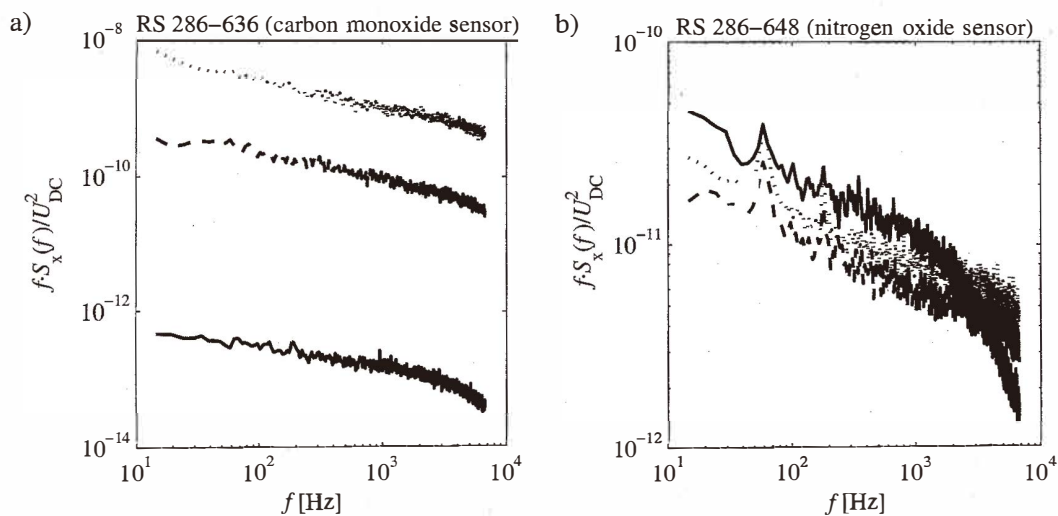

Fig. 4. Normalized power spectra of stochastic signals sampled at frequency $f_s=20$ kHz with various ambient gas mixtures: a) CO sensor, b) NOx sensor. Synthetic air (solid line), ethanol 70 ppm (dotted line) and hydrogen 380 ppm (dashed line).

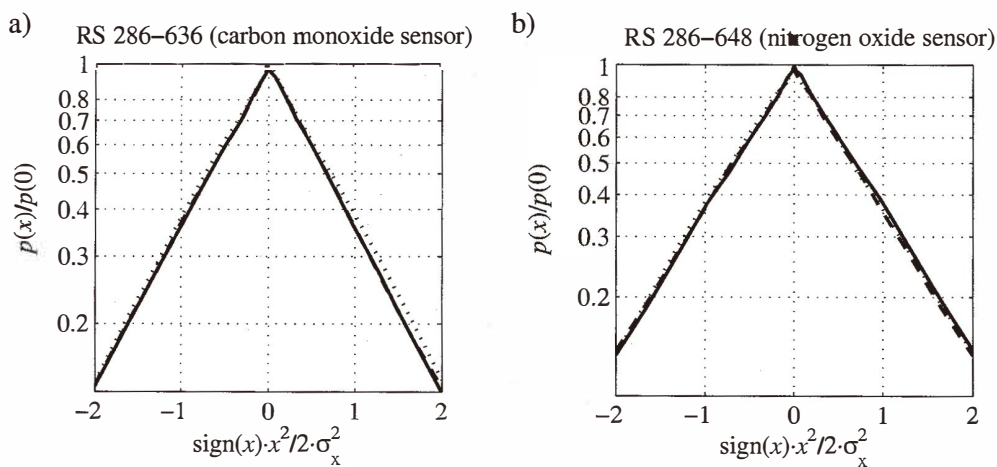

Fig. 5. Normalized amplitude distribution $p(x)/p(0)$ of voltage noise sampled at frequency $f_s=20$ kHz during exposure to synthetic air (solid line), ethanol 70 ppm (dotted line) and hydrogen 380 ppm (dashed line): a) CO sensor and b) NOx sensor.

were observed only at relatively high amplitudes in ethanol with the carbon monoxide sensor (Fig. 5(a)). In conclusion, the measured fluctuations were weakly non-Gaussian, which is a plausible result because of the large size of these sensors and due to the central limit theorem.

To explore this weak non-Gaussianity, we analyzed the bispectra of these records. At the sampling frequency of 20 kHz, the measured bispectra were nonzero only around the point $f_1=f_2=0$. This fact indicates that the most important non-Gaussian information is located at low frequencies and that its detailed study requires a lower sampling frequency.

Therefore, we ran new measurements at the sampling frequency $f_s=100$ Hz (200 times lower) to see the characteristic features at lower frequencies. For convenience, in Fig. 6 we plot the cross-level contour-plot of the absolute value of the bispectra.⁽¹¹⁾ Throughout this paper, we will refer to this plot as a *bispectrum* in accordance with existing reports in the literature. The bispectra of the four gas mixtures (Fig. 6) show distinct features in each case. The characteristic differences between these bispectra provide significantly more information, a kind of “*chemical fingerprint.*” This information is independent of the

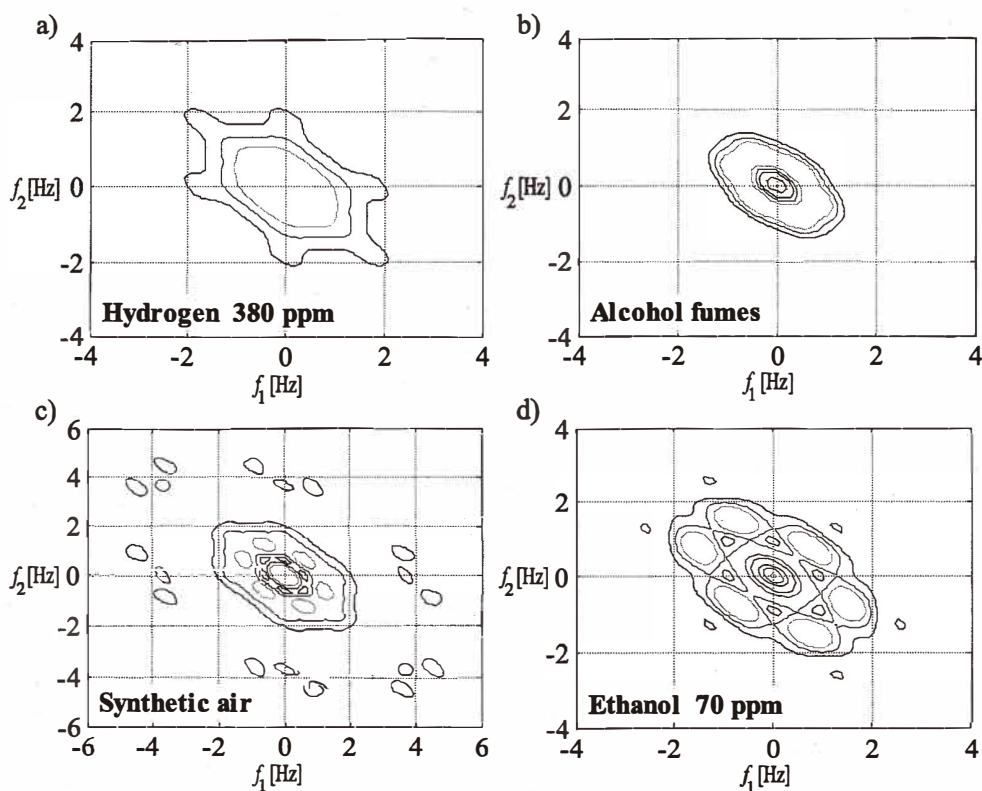

Fig. 6. Bispectra from CO sensor at sampling frequency $f_s=100$ Hz.

power spectra (Fig. 4). Thus the bispectrum is a powerful additional tool to identify various gas mixtures using a single sensor. It is important to emphasize that this goal cannot be achieved when the sensor is used in the classical way to analyze only the mean resistance because that provides only a single number instead of a rich pattern.

The axial symmetries of the obtained bispectrum functions obtained (Fig. 6) satisfy the symmetry condition for a stationary time series. This indicates that the observed nonzero bispectrum is not due to hidden nonstationary processes in the stochastic component of the sensor signal. We also ran an alternative test of stationarity. The skewness and the kurtosis were estimated from a very short time record (Fig. 7). No visible trend can be observed, which is in good agreement with the observed symmetries of the bispectra.

Finally, a few words about the accuracy and the reproducibility of data that are among the most sensitive issues in chemical sensing.

- The fluctuations of the bispectra data were reduced by averaging a large number of records. This is a more difficult task than conducting it with a classical power density spectrum. We made an effort to reduce the fluctuations in the averaged data to 5–10%. This effort required much computation time, which was in the order of half an hour using present PCs. As a result, the bispectrum patterns fluctuated weakly thus the topology and the basic shape observed by the naked eye remained the same and only the final details of the curves showed some fluctuations.

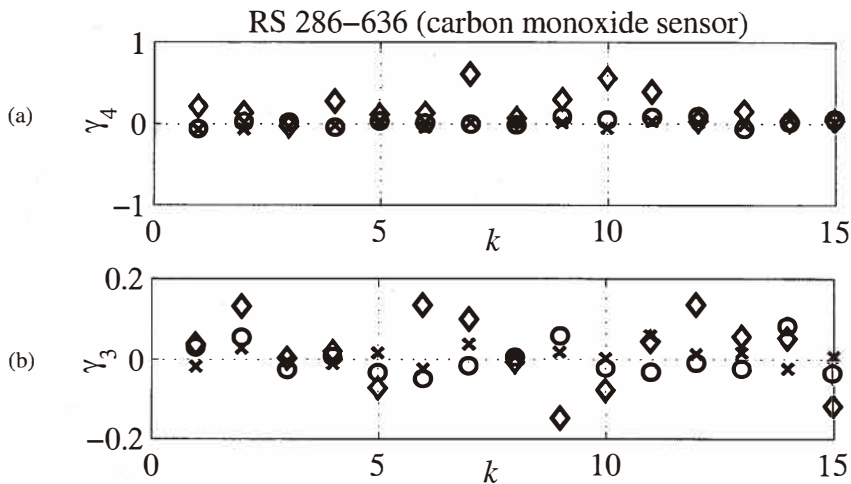

Fig. 7. Short-time-estimates of skewness and kurtosis at sampling frequency $f_s=100$ Hz with CO sensor. Synthetic air (x), ethanol 70 ppm (circle) and alcohol vapor (diamond).

- Possible effects of fluctuations of ambient gas composition. We controlled the vapor concentration by control valves (flow meters). The accuracy of the concentration was supposedly about 2%, which is high compared with the measured stochastic signal. However, the concentration fluctuations in the ambient gas have a much slower time constant due to the volume of the sensor chamber, typically in the order of a minute. Taking spectral considerations into account, the effects of these slow concentration fluctuations are reduced in our frequency regime by a factor of 10^6 – 10^{10} , because the steepness of the cutoff is at least 20 dB/decade ($1/f^2$ cutoff in the spectrum). We experimentally tested this hypothesis by switching off the gas flow for a short time. We did not observe any change in the power density spectrum of the measured fluctuations while performing this.

4. Conclusions

HOS methods were applied to test the stationarity of the stochastic component of the signals of Taguchi sensors and to extract additional chemical information from the non-Gaussian component. Various gas compositions were used. The analysis of kurtosis, skewness and bispectra indicated that the stochastic signal component was stationary. The bispectra turned out to be a rich source of additional sensing information which cannot be achieved by measuring the power spectra or analyzing the resistance in the classical way.

Acknowledgments

J.S.'s stay at Texas A&M University was sponsored by a NATO Postdoctoral Fellowship and the Faculty of Electronics, Gdansk University of Technology, Poland. The research was supported by the Army Research Lab and the Office of Naval Research. A preliminary version of the results was presented at the SPIE Conference "Noise and Information in Nanoelectronics, Sensors and Standards", Santa Fe 2003.

References

- 1 L. B. Kish, R. Vajtai and C. G. Granqvist: *Sensors and Actuators B* **71** (2000) 55.
- 2 A. Hoel, J. Ederth, J. Kopniczky, P. Heszler, L. B. Kish, E. Olsson and C. G. Granqvist: *Smart Mater. Struct.* **11** (2002) 640.
- 3 G. Schmera and L. B. Kish: *Sensors and Actuators B* **93** (2003) 159.
- 4 J. L. Solis, L. B. Kish, R. Vajtai, C. G. Granqvist, J. Olsson, J. Schnurer and V. Lantto: *Sensors and Actuators B* **77** (2001) 312.
- 5 J. Smulko, L. B. Kish and C. G. Granqvist: *Fluctuations and Noise Letters* **1** (2001) L147.
- 6 V. Lantto, P. Romppainen, and S. Leppävouri: *Sensors and Actuators B* **14** (1988) 149.
- 7 R. F. Voss: *Phys. Rev. Lett.* **40** (1978) 913.
- 8 A. V. Yakimov and F. N. Hooge: *Physica B* **291** (2000) 97.
- 9 R. Crook and B. K. Jones: *Microelectronics and Reliability* **37** (1997) 1635.
- 10 T. Schreiber and A. Schmitz: *Physical Rev. E* **55** (1997) 5443.
- 11 A. Swami and J. M. Mendel: *Higher-order spectral analysis toolbox for use with Matlab* (Mathworks Inc., Natick, 1998).